

FYLS-0805BHRC

Radiation pattern.

Features:

- Compatible with automatic placement equipment
- Compatible with reflow solder process.

Applications:

- Automotive-Telecommunication
- Indicators
- Lcd Back-lights
- Illuminations

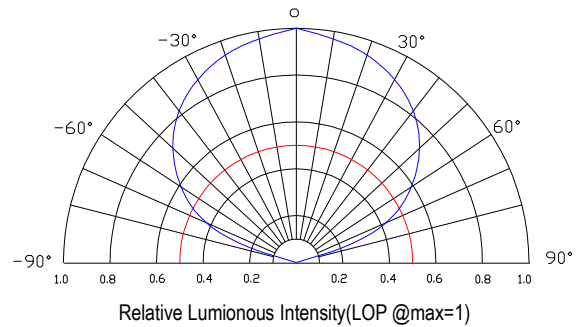

Descriptions:

- Dice material: AlGaAs.
- Emitting Color: high Red.
- Lens Color: Water clear.

Absolute maximum ratings(Ta=25 °c)

Parameter	MAX.	Unit
Power Dissipation	50	mW
Peak Forward Current (1/10 Duty Cycle, 0.1ms Pulse)	100	mA
Continuous Forward Current	30	mA
Derating Linear From 25°C	0.4	mA/°C
Operating Temperature Range	-30°C to +80°C	
Storage Temperature Range	-40°C to +85°C	

Electrical and optical characteristics(Ta=25 °c)

Parameter	Symbol	Min.	Typ.	Max.	Unit	Test Condition
Luminous Intensity	IV	-	25	-	mcd	IF=20mA
Viewing Angle	2θ1/2	120	130	140	Deg	
Peak Emission	λp	655	660	665	nm	
Dominant Wavelength	λd	635	640	645	nm	
Spectral Line Half-Width	Δλ	25	30	35	nm	
Forward Voltage	VF		2.1	2.4	V	
Reverse Current	IR			10	μA	VR=5V

Typical Electrical Characteristics Curves (25 °c Ambient Temperature Unless Otherwise Noted)

Spectral Reduance

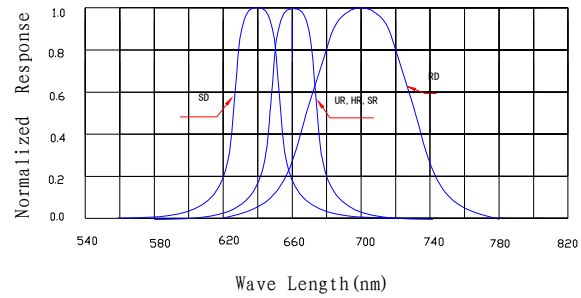

Luminous Intensity Vs. forward Current

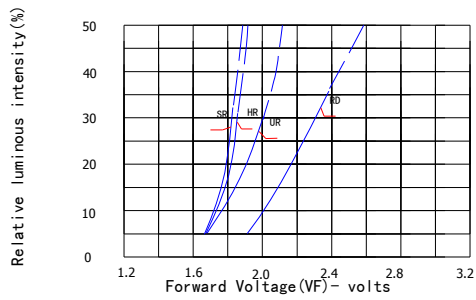

Luminous Intensity Vs. forward Current

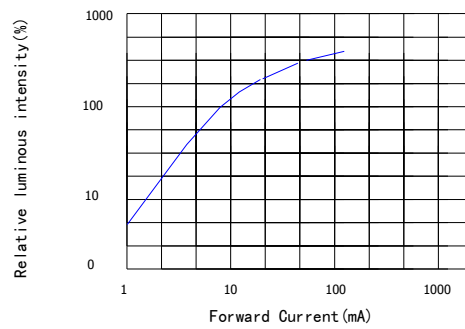

Luminous Intensity Vs. Ambient Temperature

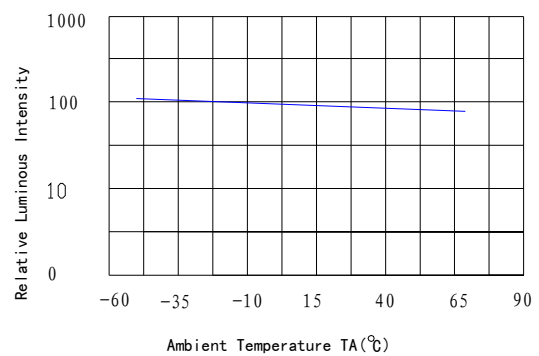

Forward Current Derating Curve

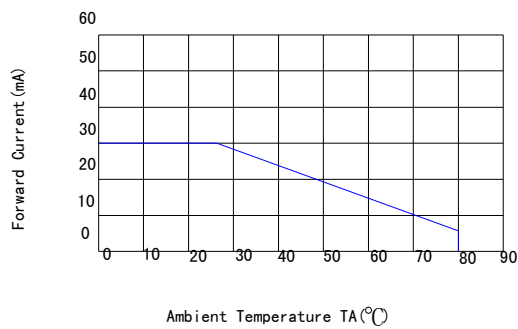

◆ **Precautions For Use**

● **Over-current-proof**

Customer must apply resistors for protection, otherwise slight voltage shift will cause big current change (Burn out will happen)

● **Storage**

1. The operation of temperature and R.H are: $5^{\circ}\text{C} - 30^{\circ}\text{C}$, R.H. 60% Max.
2. Once the package is opened, the products should be used within a week. Otherwise, they should be kept in a damp proof box with desiccating reagent. Considering the tape life, we suggest our customers to use our products within 1.5 year (from production date).
3. It's recommended to bake before soldering when the package is unsealed after 72hrs. The condition is: $60^{\circ}\text{C} \pm 5^{\circ}\text{C}$ for 15 hrs.

◆ **Soldering Iron:**

- Temperature at tip of iron: 300°C Max. (25W Max)
- Soldering time: 3 ± 1 sec.

◆ **Reflow Temp./Time:**

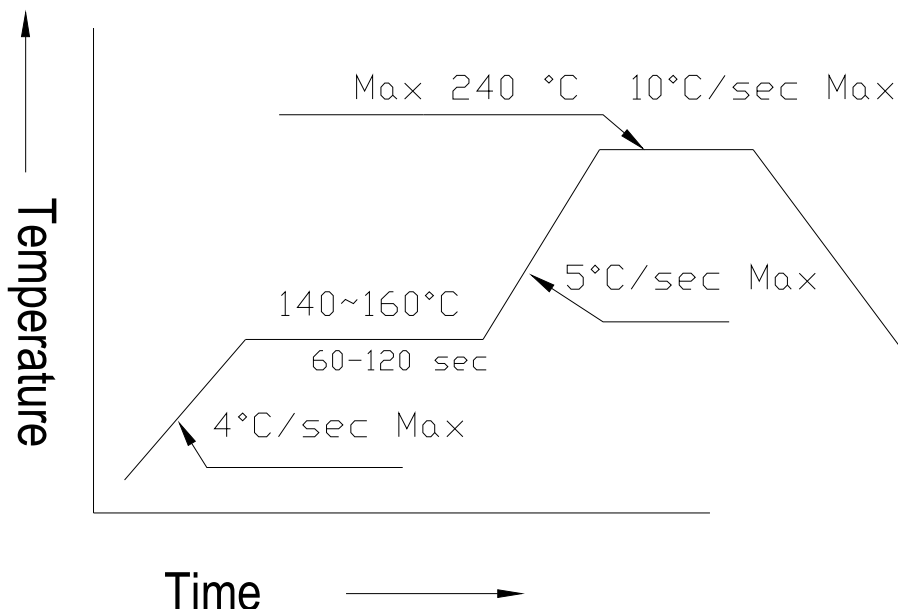

◆ Package Dimensions of Device

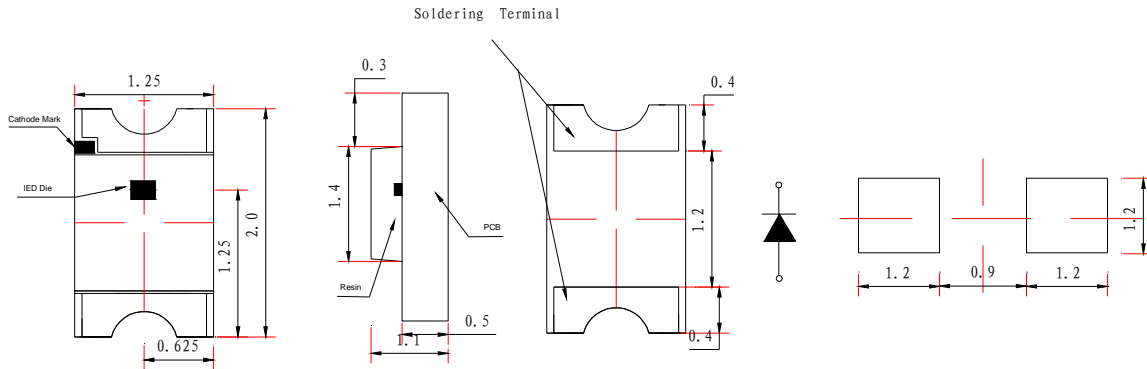

Unit:mm

◆ Tape Specification:3000pcs Per Reel.

Packing Size								
Item	W	P1	E	F	D0	D1	P0	Unit
Spec.	8.00	4.00	1.75	3.50	1.50	1.0	4.00	mm
Tolerance	±0.20	±0.10	±0.10	±0.05	+0.1/-0	±0.05	±0.05	mm
Item	10P0	P2	A0	B0	K0	T		Unit
Spec.	40.00	2.00	1.40	2.25	1.35	0.23		mm
Tolerance	±0.20	±0.05	±0.10	±0.10	±0.10	±0.05		mm

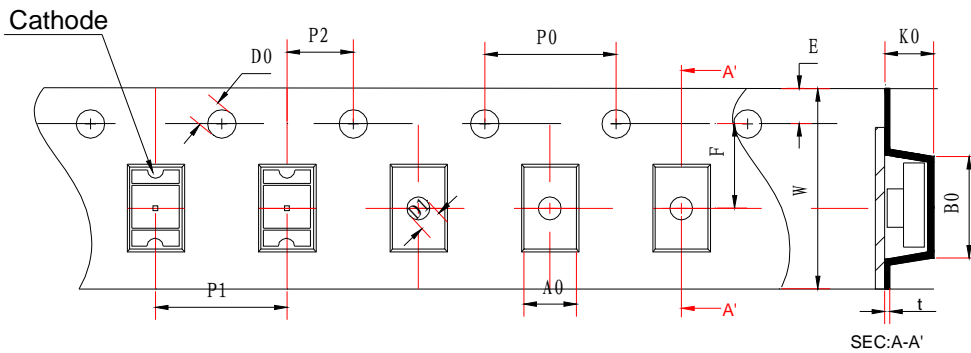

◆ Package Dimensions of Reel:

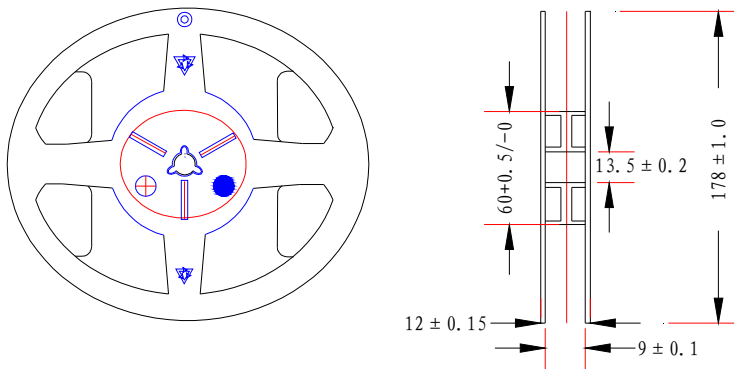

Unit:mm

◆ Packing and Shipping Spec.

