

FYLF- 1130UW1C

Features:

- High intensity
- General purpose leads
- RoHs complant.

Descriptions:

- Dice material: InGaN
- Emitting Color: White
- Lens Type: Water clear

Radiation pattern.

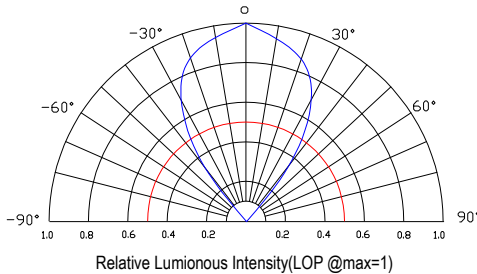

Package configuration

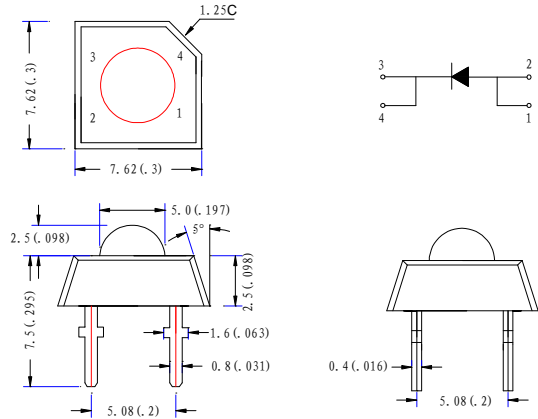

- ◆ All dimensions are millimeters (inches)
- ◆ Tolerance is $\pm 0.25\text{mm}(0.010\text{'})$ unless otherwise noted.

Absolute maximum ratings($T_a=25\text{ }^\circ\text{C}$)

Parameter	MAX.	Unit
Power Dissipation	70	mW
Peak Forward Current (1/10 Duty Cycle, 0.1ms Pulse Width)	100	mA
Continuous Forward Current	20	mA
Derating Linear From $50\text{ }^\circ\text{C}$	0.4	mA/ $^\circ\text{C}$
Reverse Voltage	5	V
Electrostatic Discharge (ESD)	150	V
Operating Temperature Range	$-20\text{ }^\circ\text{C}$ to $+80\text{ }^\circ\text{C}$	
Storage Temperature Range	$-30\text{ }^\circ\text{C}$ to $+100\text{ }^\circ\text{C}$	
Lead Soldering Temperature[4mm(.157") From Body]	260 $^\circ\text{C}$ for 5 Seconds	

Electrical and optical characteristics($T_a=25\text{ }^\circ\text{C}$)

Parameter	Symbol	Min.	Typ.	Max.	Unit	Test Condition
Luminous Intensity	I_V	-	2000	-	mcd	$I_F=20\text{mA}$
Viewing Angle	$2\theta_{1/2}$	65	75	85	Deg	
Chromaticity coordinates	x		0.29			
	y		0.30			
CCT			9000		K	
Forward Voltage	V_F	2.8	3.2	3.6	V	
Reverse Current	I_R			50	μA	$V_R=5\text{V}$

Typical Electrical Characteristics Curves (25 °c Ambient Temperature Unless Otherwise Noted)

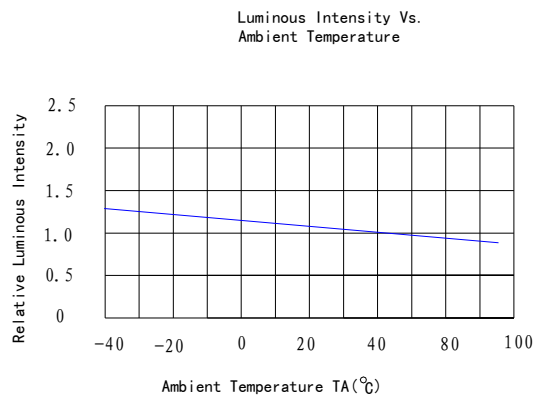
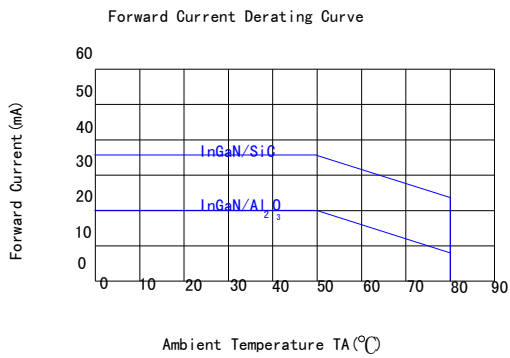
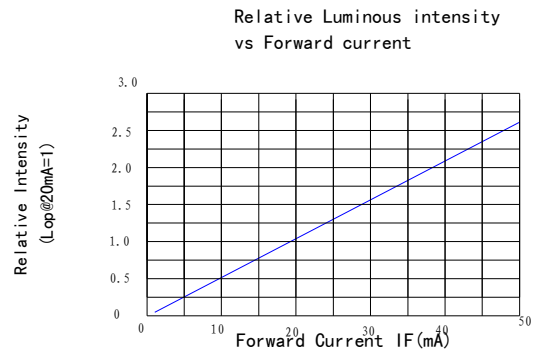
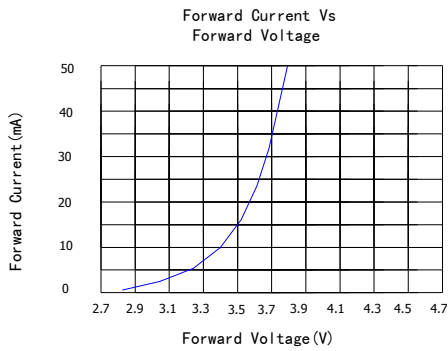
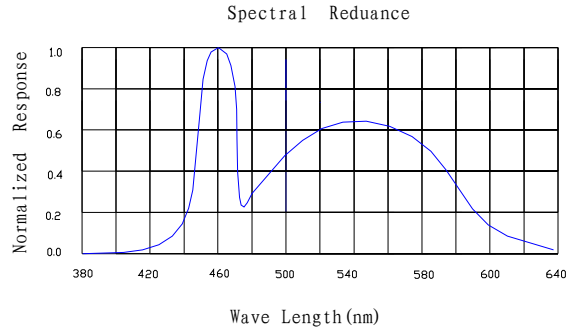

Flux LEDs PACKING.

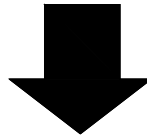
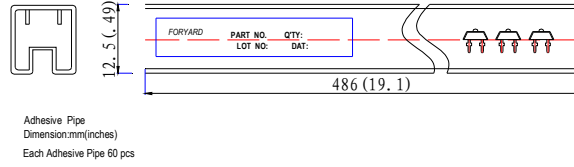
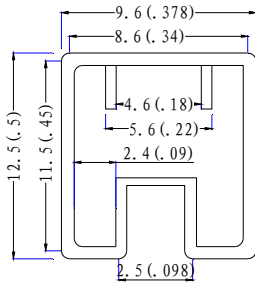

Box
Dimension (cm) : 53*15*16.5

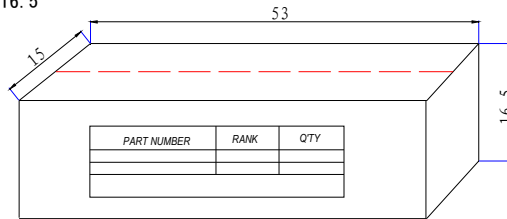

Each box/carton 10,000pcs

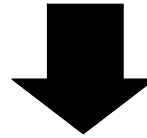

CARTON
Dimension(cm):56*32*34.4

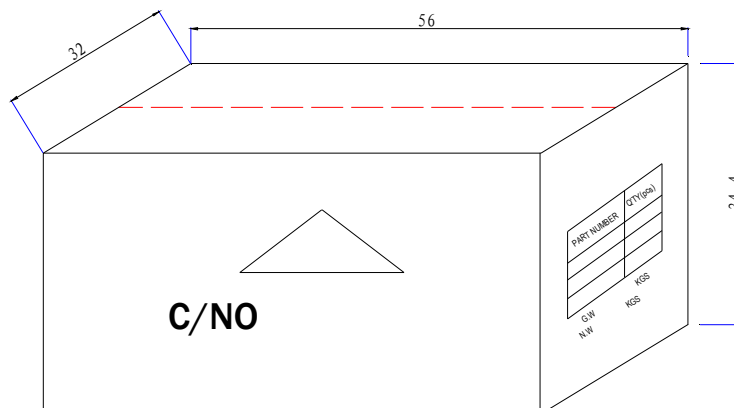

4 Boxes/Carton
Total :40,000pcs